

Data Sheet



Article number: 204250M1080A0S

Description: E+G levelling foot

GN 42-50-M10-80-A0-S

Note: S Without nut, External hexagon at the bottom

Measures

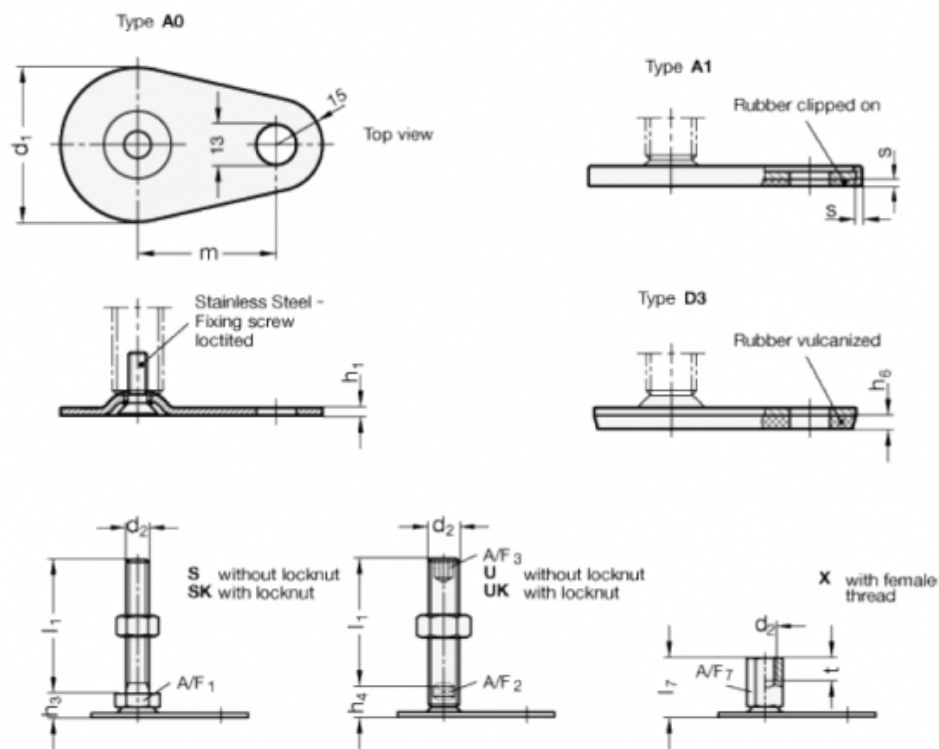

A/F1 = 17

d1 = 50

d2 = M10

h1 = 2.5

h3 = 11

h6 =

l1 = 80

m = 45

s =